

GSM 900 RF REPEATER

Model No : ACR - 900 -1W

DESCRIPTION:

The repeater system is a two-way amplifier that provides booster performance to extend the coverage of radio communications in buildings, basements and other RF shadow areas. The Repeater receives signals from one antenna, amplifies them and transmits through the other antenna. This enlarges coverage of cellular base stations.



Features such as high linearity amplifier characteristics, and sharp out of band rejection duplexers, assist in avoiding interfering signals & makes it an ideal solution for in-building installation.

Main Features:

- In-Building Solution
- Linear Operation
- More Gain in Downlink Chain
- Manual Gain Adjustment Facility
- Compact size
- Cost Effective Solution
- Ease of Installation

Regd. & Corporate Office

Plot No. 16, Sector-III, HUDA Techno Enclave,
Opp. K. Raheja IT Park, Madhapur,
Hyderabad - 500 081, India.
Tel : +91-40-2311 5050/51/52
Fax : +91-40-2311 2336

Production Unit

Sy. No. 227 & 229, Plot No. 31, Phase-II
IDA, Cherlapally, R.R. District,
Hyderabad - 500 051, India.
Tel : +91-40-2726 2999, 6458 5519
Fax : +91-40-2726 2888

Avantel Limited

www.avantel.in
info@avantel.in

GSM 900 RF REPEATER

Model No : ACR - 900 -1W

Block Diagram:

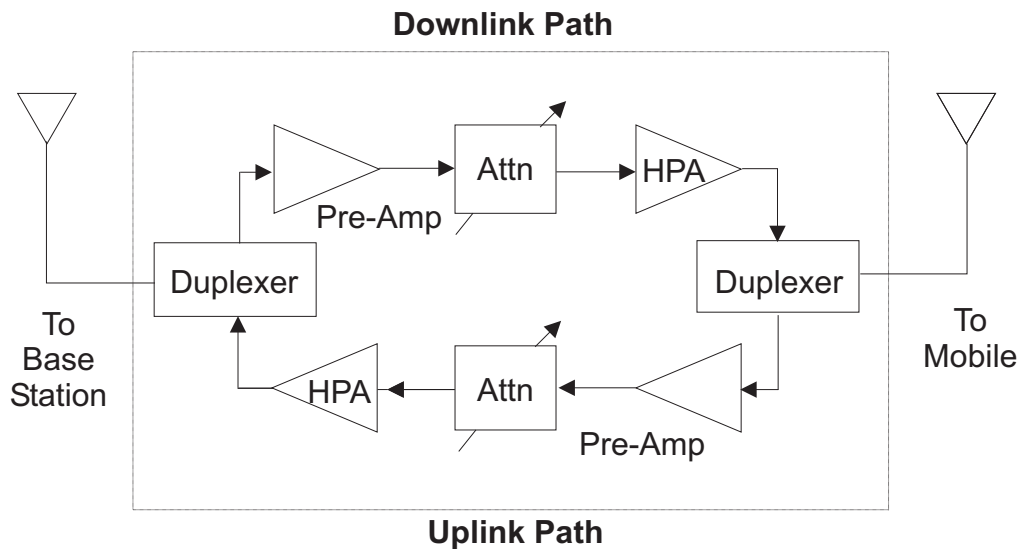

SPECIFICATIONS:

Downlink	Uplink
Frequency Range : 935 to 960 MHz	Frequency Range : 890 to 915 MHz
Pass Band Gain : 60 ± 1 dB	Pass Band Gain : 55 ± 1 dB
Freq. Response : ± 1.5 dB	Freq. Response : ± 1.5 dB
Manual Gain Adjustment : 30 dB	Manual Gain Adjustment : 30 dB
Output power : +30 dBm	Output power : +30 dBm
Impedance : 50	Impedance : 50
Return loss : >10 dB	Return loss : >10 dB

RF Connectors : N(F)
Supply Voltage : 230 V AC
Operating Temperature : 0 to +50 deg
Weight : 7 kg